

2021 INTERNATIONAL RESIDENTIAL CODE CHANGES AS OF JANUARY 01, 2023

Wind 130mph -160mph: This list includes the special wind region Exceeding 130mph-160mph as indicated in Figure R301.2.1.1

R302.1 Exterior Walls - Fire Rating (Walls, Projections, and Eaves) . Construction, projections, openings and penetrations of exterior walls of dwellings and accessory buildings shall comply with Table R302.1(1); or dwellings equipped throughout with an automatic sprinkler system installed in accordance with Section P2904 shall comply with Table R302.1(2).

Exceptions:

- 1.Walls, projections, openings or penetrations in walls perpendicular to the line used to determine the fire separation distance.
- 2.Walls of individual dwelling units and their accessory structures located on the same lot.
- 3.Detached tool sheds and storage sheds, playhouses and similar structures exempted from permits are not required to provide wall protection based on location on the lot. Projections beyond the exterior wall shall not extend over the lot line.
- 4.Detached garages accessory to a dwelling located within 2 feet (610 mm) of a lot line are permitted to have roof eave projections not exceeding 4 inches (102 mm).
- 5.Foundation vents installed in compliance with this code are permitted.

**TABLE R302.1(1)
EXTERIOR WALLS**

EXTERIOR WALL ELEMENT		MINIMUM FIRE-RESISTANCE RATING	MINIMUM FIRE SEPARATION DISTANCE
Walls	Fire-resistance rated	1 hour—tested in accordance with ASTM E 119 or UL 263 with exposure from both sides	< 5 feet
	Not fire-resistance rated	0 hours	≥ 5 feet
	Not allowed	N/A	< 2 feet
Projections	Fire-resistance rated	1 hour on the underside ^{a, b}	≥ 2 feet to < 5 feet
	Not fire-resistance rated	0 hours	≥ 5 feet
Openings in walls	Not allowed	N/A	< 3 feet
	25% maximum of wall area	0 hours	3 feet
	Unlimited	0 hours	5 feet
Penetrations	All	Comply with Section R302.4	< 3 feet
		None required	3 feet

For SI: 1 foot = 304.8 mm.
N/A = Not Applicable.

- a. Roof eave fire-resistance rating shall be permitted to be reduced to 0 hours on the underside of the eave if fireblocking is provided from the wall top plate to the underside of the roof sheathing.
- b. Roof eave fire-resistance rating shall be permitted to be reduced to 0 hours on the underside of the eave provided that gable vent openings are not installed.

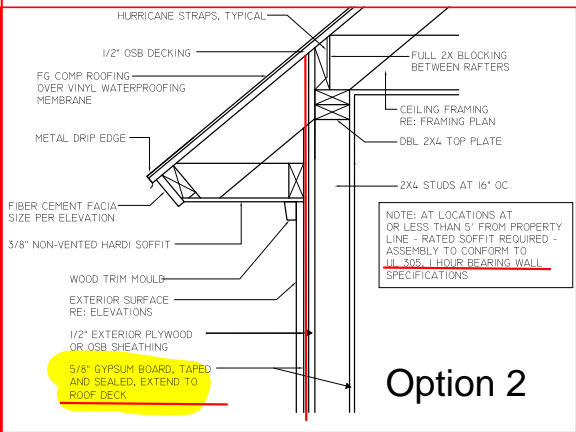
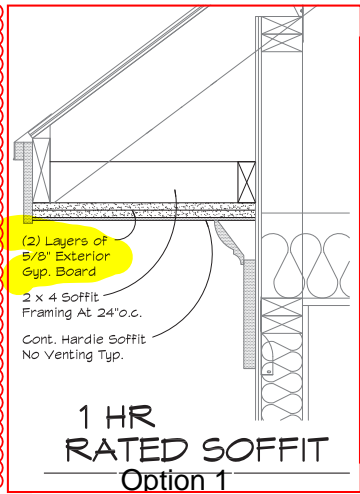

R302.5 Dwelling-garage opening and penetration protection. Openings and penetrations through the walls or ceilings separating the dwelling from the garage shall be in accordance with Sections R302.5.1 through R302.5.3.

R302.5.1 Opening protection. Openings from a private garage directly into a room used for sleeping purposes shall not be permitted. Other openings between the garage and residence shall be equipped with solid wood doors not less than 1 3/8 inches (35 mm) in thickness, solid or honeycomb-core steel doors not less than 1 3/8 inches (35 mm) thick, or 20-minute fire-rated doors. **Doors shall be self-latching and equipped with a self-closing or an automatic-closing device.**

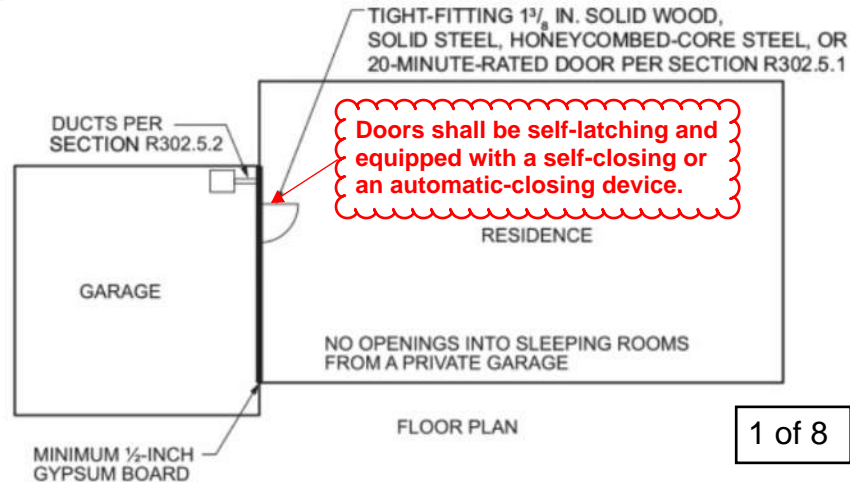

R302.13 Fire protection of floors above crawl spaces containing fuel-fired or electric-powered heating appliances. Floor assemblies that are not required elsewhere in this code to be fire-resistance rated, shall be provided with a 1/2-inch (12.7 mm) gypsum wallboard membrane, 5/8-inch (16 mm) wood structural panel membrane, or equivalent on the underside of the floor framing member. Penetrations or openings for ducts, vents, electrical outlets, lighting, devices, luminaires, wires, speakers, drainage, piping and similar penetrations shall be permitted.

Exceptions:

1. Floor assemblies located directly over a space protected by an automatic sprinkler system in accordance with Section P2904, NFPA 13D
2. Floor assemblies located directly over a crawl space not intended for storage or for the installation of fuel-fired or electric-powered heating appliances.
3. Portions of floor assemblies shall be permitted to be unprotected where complying with the following:
 - 3.1. The aggregate area of the unprotected portions does not exceed 80 square feet (7.4 m²) per story.
 - 3.2. Fireblocking in accordance with Section R302.11.1 is installed along the perimeter of the unprotected portion to separate the unprotected portion from the remainder of the floor assembly.
 4. Wood floor assemblies using dimension lumber or structural composite lumber equal to or greater than 2-inch by 10-inch (50.8 mm by 254 mm) nominal dimension, or other approved floor assemblies demonstrating equivalent fire performance.

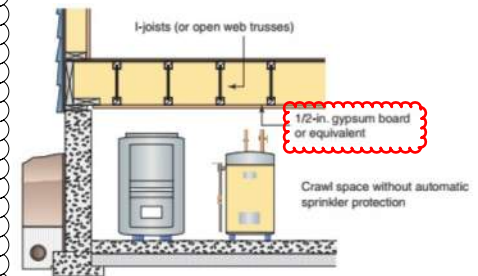

R308.4.2 Glazing adjacent to doors. Glazing in an individual fixed or operable panel adjacent to a door shall be considered to be a hazardous location where the bottom exposed edge of the glazing is less than 60 inches (1524 mm) above the floor or walking surface and it meets either of the following conditions:

1. Where the glazing is within 24 inches (610 mm) of either side of the door in the plane of the door in a closed position.
2. Where the glazing is on a wall to less than 180 degrees (3.14 rad) from the plane of the door in a closed position and within 24 inches (610 mm) of the hinge side of an in-swinging door.

Exceptions:

1. Decorative glazing.
2. Where there is an intervening wall or other permanent barrier between the door and the glazing.
3. Where access through the door is to a closet or storage area 3 feet (914 mm) or less in depth. Glazing in this application shall comply with Section R308.4.3.
4. Glazing that is adjacent to the fixed panel of patio doors.

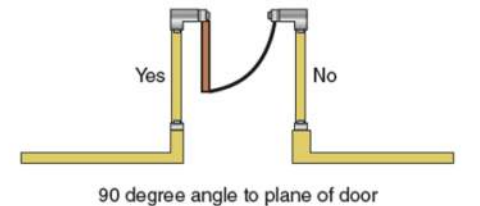
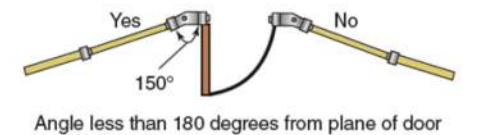
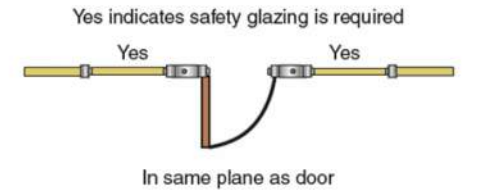

R308.4.4 Glazing in guards and railings. Glazing in guards and railings, including structural baluster panels and nonstructural in-fill panels, regardless of area or height above a walking surface shall be considered to be a hazardous location.

R308.4.4.1 Structural glass baluster panels. Guards with structural glass baluster panels shall be installed with an attached top rail or handrail. The top rail or handrail shall be supported by not less than three glass baluster panels, or shall be otherwise supported to remain in place should one glass baluster panel fail.

Exception: An attached top rail or handrail is not required where the glass baluster panels are laminated glass with two or more glass plies of equal thickness and of the same glass type.



R310.1 Emergency escape and rescue openings require a clear 36-inch-wide path to a public way.

Exceptions:

1. Storm shelters and basements used only to house mechanical equipment not exceeding a total floor area of 200 square feet.
2. Where the dwelling unit or townhouse unit is equipped with an automatic sprinkler system installed in accordance with Section P2904, sleeping rooms in basements shall not be required to have emergency escape and rescue openings provided that the basement has one of the following:
 - 2.1. One means of egress complying with Section R311 and one emergency escape and rescue opening.
 - 2.2. Two means of egress complying with Section R311.
3. A yard shall not be required to open directly into a public way where the yard opens to an unobstructed path from the yard to the public way. **Such path shall have a width of not less than 36 inches (914 mm).**

R310.1.1 Operational constraints and opening control devices. Emergency escape and rescue openings shall be operational from the inside of the room without the use of keys, tools or special knowledge. Window opening control devices and fall prevention devices complying with ASTM F2090 shall be permitted for use on windows serving as a required emergency escape and rescue opening and shall be not more than 70 inches (178 cm) above the finished floor.

R310.2.4 Emergency escape and rescue openings under decks porches and cantilevers. Emergency escape and rescue openings installed under decks, porches and cantilevers shall be fully openable and provide a path not less than 36 inches (914 mm) in height and 36 inches (914 mm) in width to a yard or court.

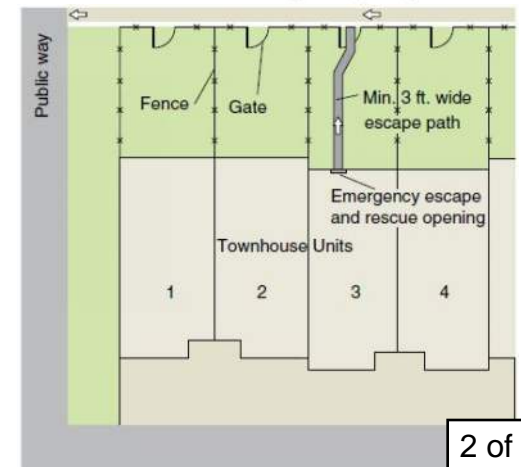

Smoke Alarms R314.3 & Carbon Monoxide Alarms R315.7

R314.3 Smoke Alarms Additional Alarm location

5. In the hallway and in the room open to the hallway in dwelling units where the ceiling height of a room open to a hallway serving bedrooms exceeds that of the hallway by 24 inches (610 mm) or more.

Interconnection. Where more than one smoke alarm is required to be installed within an individual dwelling unit in accordance with Section R314.3, the alarm devices shall be interconnected in such a manner that the actuation of one alarm will activate all of the alarms in the individual dwelling unit. Physical interconnection of smoke alarms shall not be required where listed **wireless alarms** are installed and all alarms sound upon activation of one alarm. R314.4

Carbon Monoxide Alarms required when a standby generator installed outside or gas equipment serviced or installed

R315.2.1 **New Construction** - For new construction, carbon monoxide alarms shall be provided in dwelling units where either or both of the following conditions exist. (IRC R315.2.1)

1. The dwelling unit contains a fuel-fired appliance.
2. The dwelling unit has an attached garage with an opening that communicates with the dwelling unit.
3. When the dwelling unit utilizes a permanent fuel fired appliance, including a standby generator is installed outside, carbon monoxide alarms are to be installed inside of each separate sleeping room and one in the living area. (LSUCCC Amendment)

Interconnectivity - Where more than one carbon monoxide alarm is required to be installed within an individual dwelling unit, the alarm devices shall be interconnected in such a manner that the actuation of one alarm will activate all the alarms in the individual dwelling unit. Physical interconnection of carbon monoxide alarms shall not be required where listed wireless alarms are installed and all alarms sound upon activation of one alarm. (R315.5)

Power Source - Carbon monoxide alarms shall receive their primary power from the building wiring where such wiring is served from a commercial source and, where primary power is interrupted, shall receive power from a battery. The wiring shall be permanent and without a disconnecting switch other than those required for overcurrent protection. (IRC R315.6)

Alterations, Repairs, Additions (Existing Structures) - Where alterations, repairs or additions requiring a permit occur, and where any of the conditions above exist that require carbon monoxide alarms for new construction. (IRC R315.2.2) When the dwelling unit utilizes a permanent fuel fired appliance, including a standby generator is installed outside, carbon monoxide alarms are to be installed inside of each separate sleeping room and one in the living area. If there are existing hard wired interconnected smoke detectors, they can be replaced with combination smoke/CO alarms using the existing hard-wired system or the owner/contractor could choose to install stand-alone battery type CO detectors with a long-life sealed battery in the locations required.

Exceptions

1. Work involving the exterior surfaces of dwellings, such as the replacement of roofing or siding, or the addition or replacement of windows or doors, or the addition of a porch or deck. (IRC R315.2.2)
2. Installation, alteration, or repairs of plumbing systems.
3. Installation, alteration or repairs of mechanical systems that are not fuel fired.

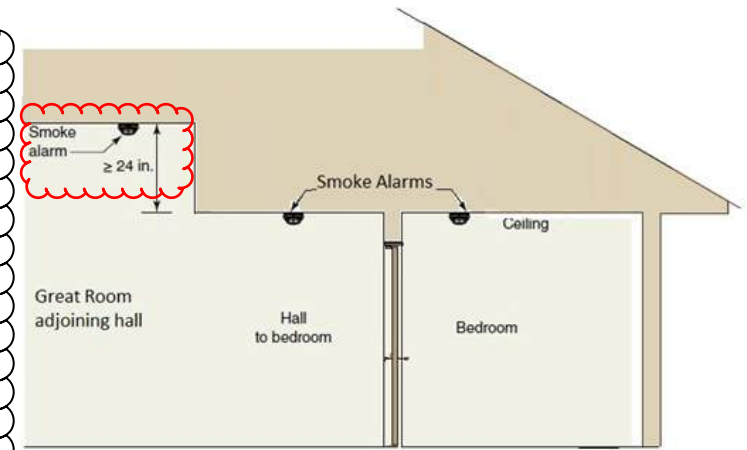

Section drawing

R311.7.3 Stairways vertical rise between landings increased 4 inches to 12'-7"

A flight of stairs shall not have a **vertical rise** greater than 12 feet 7 inches between floor levels or landings [IRC R311.7.3].

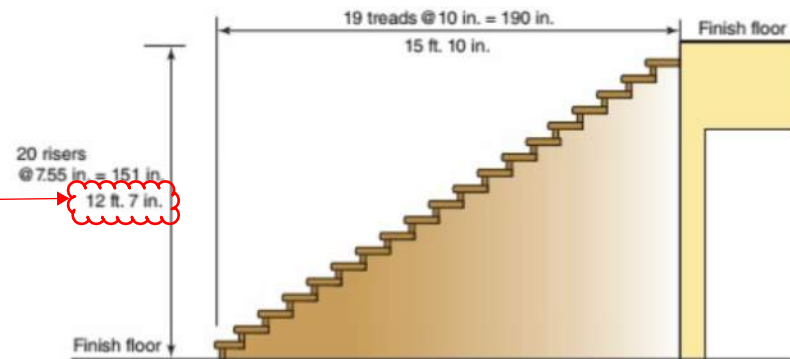

Maximum 151-inch total rise between floors or landings

UNDERLAYMENT AND ICE BARRIER DETAILS

Roof Covering Material: IRC 905, Table R905.1.1(2), Table R905.1.1(3)

Underlayment shall be two layers applied in the following manner: apply a 19-inch strip of underlayment felt parallel to and starting at the eaves. Starting at the eave, apply 36-inch-wide sheets of underlayment, overlapping successive sheets 19 inches. Distortions in the underlayment shall not interfere with the ability of the shingles to seal. End laps shall be 4 inches and shall be offset by 6 feet [IRC T905.1.1(2)]. The underlayment shall be attached with corrosion-resistant fasteners in a grid pattern of 12 inches between side laps with a 6-inch spacing at side and end laps. Underlayment shall be attached using annular ring or deformed shank nails with 1-inch-diameter metal or plastic cap [IRC T905.1.1(3)].

The use of 30 lb. felt or synthetic approved underlayment (15lb felt NOT allowed). The underlayment shall be attached with corrosion-resistant fasteners in a grid pattern of 12 inches between side laps with a 6-inch spacing at the side laps and end laps. Underlayment shall be attached using annular ring or deformed shank nails with 1-inch-diameter metal or plastic caps. [IRC T905.1.1(3)].

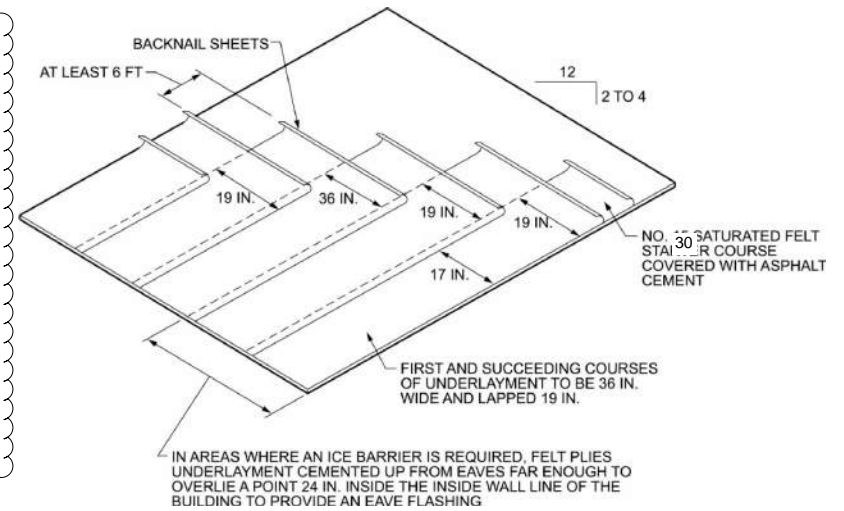

DOUBLE-PLY UNDERLAYMENT APPLICATION REQUIREMENT

Table 3.23C Full Height Stud Requirements for Headers or Window Sill Plates in Exterior Walls Resisting Wind Loads

Exposure B & C

Header Span (ft)	Wall Stud Spacing (in.)		
	12	16	24
2	1	1	1
4	2	2	1
6	3	3	2
8	4	3	2
10	5	4	3
12	6	5	3
14	7	6	4
16	8	6	4
18	9	7	5
20	10	8	5

1 The number of full height studs required at each end of the header shall be permitted to be reduced in accordance with the requirements of Section 3.4.1.4.2 and Table 3.23D.

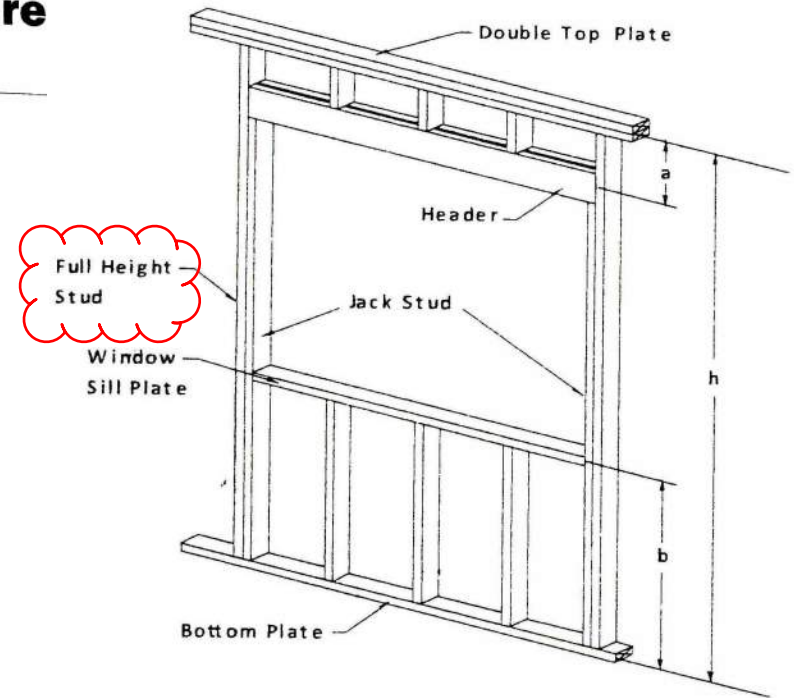

Gable end overhangs framed with look out blocks limited to 9"

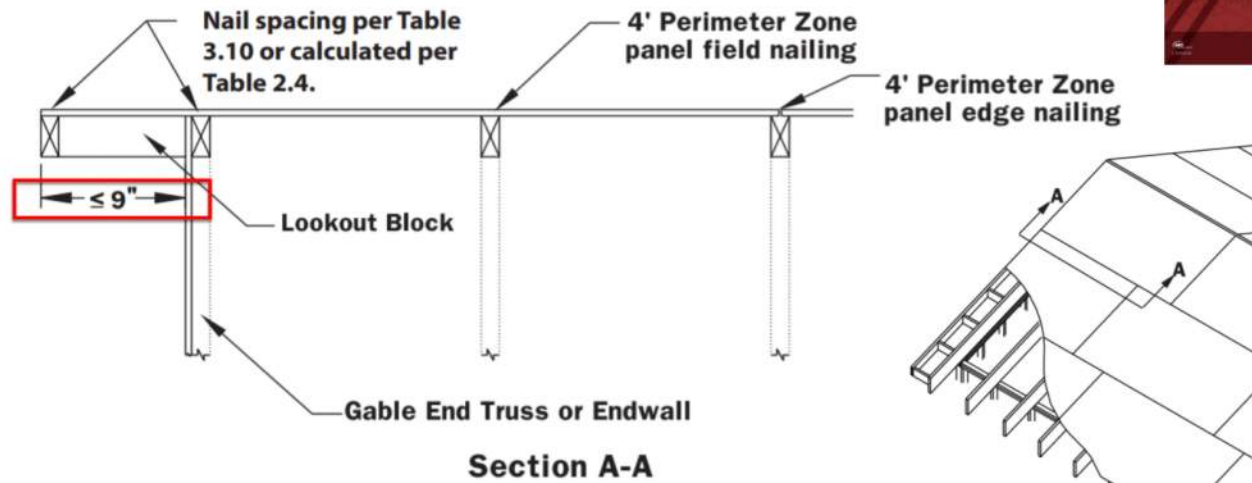

Limits for Rake Overhang Using Lookout Blocks (2018 WFCM Figure 2.1h)

R1005.8 Insulation shield Where factory-built chimneys pass through insulated assemblies, an insulation shield constructed of steel having a thickness of not less than 0.0187 inch (0.4712 mm) (No. 26 gage) shall be installed to provide clearance between the chimney and the insulation material. The clearance shall be not less than the clearance to combustibles specified by the chimney manufacturer's installation instructions. Where chimneys pass through attic space, the shield shall terminate not less than 2 inches (51 mm) above the insulation materials and shall be secured in place to prevent displacement. Insulation shields provided as part of a listed chimney system shall be installed in accordance with the manufacturer's installation instructions.



2021 FUEL GAS CHANGES AS OF JANUARY 01, 2023

G2414.4.2 (403.4.2) Steel Gas Pipe The code now allows **Schedule 10 steel pipe for fuel gas piping**. stainless steel and wrought-iron pipe shall be not lighter than **Schedule 10** and shall comply with the dimensional standards of ASME B36.10, 10M and one of the following standards: 1.ASTM A53/A53M. 2.ASTM A106.3.ASTM A312.

G2420.6 Shutoff valves in tubing systems. Shutoff valves installed in tubing systems shall be rigidly and securely **supported** independently of the tubing.

G2447.2 Commercial Cooking Appliances Prohibited Cooking appliances that are designed for permanent installation, including ranges, ovens, stoves, broilers, grills, fryers, griddles, hot plates and barbecues, shall be listed in accordance with ANSI Z21.1 or ANSI Z21.58/CSA 1.6 and shall be installed in accordance with the manufacturer's instructions.

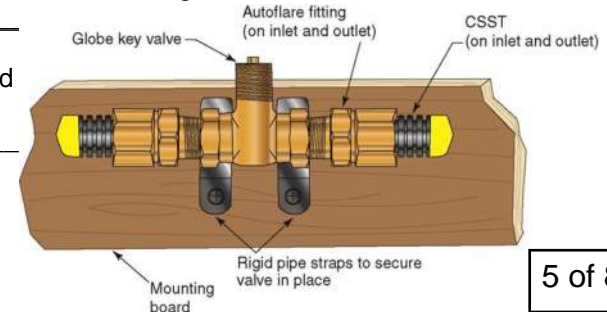

2021 PLUMBING CHANGES AS OF JANUARY 01, 2023

Plumbing:

P2503.7 Water-supply system testing. Compressed-air testing of PEX water-supply piping is now allowed when testing is in accordance with the manufacturer's instructions.

P2704.1 Slip joints. Slip joint connections are permitted anywhere between the fixture outlet and the drainage piping and are no longer limited to the trap inlet, outlet and trap seal locations. Slip joint connections shall be installed only for tubular waste piping and only between the trap outlet of a fixture and the connection to the drainage piping. Slip joint connections shall be made with an approved elastomeric sealing gasket. Slip joint connections shall be provided with access. Such access shall provide an opening that is not less than 12 inches (305mm) in its smallest dimension.

P2708.4 Shower control valves. The code now addresses Lower flow shower heads being compatible with the shower control mixing valve. Shower control valves shall be rated for the flow rate of the installed shower head. Such valves shall be installed at the point of use. Shower and tub/shower combination valves required by this section shall be equipped with a means to limit the maximum setting of the valve to 120°F (49°C), which shall be field adjusted in accordance with the manufacturer's instructions to provide water at a temperature not to exceed 120°F. In-line thermostatic valves shall not be utilized for compliance with this section.

P2713.1 Bathtub waste outlets and overflows. Bathtub overflow outlets are **no longer required**.

P2713.3 Bathtub and whirlpool bathtub valves. The code now addresses field adjustment and access to shower control valves. Bathtub and whirlpool bathtub valves shall have or be supplied by a water-temperature limiting device that conforms to ASSE 1070/ASME A112.1070/CSA B125.70 except where such valves are combination tub/shower valves in accordance with Section P2708.4. The water temperature limiting device required by this section shall be equipped with a means to limit the maximum setting of the device to 120°F (49°C), and, where adjustable, shall be field adjusted in accordance with the manufacturer's instructions to provide hot water at a temperature not to exceed 120°F (49°C). conform to ASSE 1070/ASME A112.1070/CSA B125.70. Access shall be provided to adjustable water-temperature-limiting devices.

P2903.5 Water hammer. A water hammer arrestor shall be installed where quick-closing valves are utilized. Water-hammer arrestors shall be installed in accordance with the manufacturer's instructions and conform to ASSE 1010. QUICK-CLOSING VALVE. A valve or faucet that closes automatically when released manually or controlled by mechanical means for fast-action closing. Typical quick-closing valves include electrically actuated valves such as those found in dishwashing machines, clothes washing machines.

P2905.3 Hot water supply to fixtures. The developed length of hot water piping, from the source of hot water to the fixtures that require hot water, **shall not exceed 100 feet** (30 480 mm). Water heaters and recirculating system piping shall be considered to be sources of hot water.

P3003.2 Prohibited Joints New exception : A solvent cement joint is now permitted for joining ABS and PVC piping at the connection of the building drain to the building sewer. P3003.13.4 Plastic pipe or tubing to other piping material. Joints between different types of plastic pipe shall be made with an approved adapter fitting or **by a solvent-cement joint only where a single joint is made between ABS and PVC pipes at the end of a building drainage pipe and the beginning of a building sewer pipe using a solvent cement complying with ASTM D3138.**

P3005.1.6 Reduction in Pipe Size: Additional Exceptions, Not considered pipe size reductions Water closet offset bend fittings and offset flanges.

P3005.2.10.1 Clean-out Equivalent. A fixture trap or a fixture with an integral trap, removable without altering the concealed piping shall be acceptable as a clean-out equivalent.

P3103.1.3 Roof extension covered. Where an open vent pipe terminates above a sloped roof and is covered by either a roof-mounted panel (such as a **solar collector or photovoltaic panel mounted over the vent opening**) or a roof element (such as an architectural feature or a decorative shroud), the vent pipe shall terminate not less than 2 inches (51 mm) above the roof surface. Such roof elements shall be designed to prevent the adverse effects of snow accumulation and wind on the function of the vent. The placement of a panel over a vent pipe and the design of a roof element covering **the vent pipe shall provide for an open area for the vent pipe to the outdoors that is not less than the area of the pipe**, as calculated from the inside diameter of the pipe. Such vent terminals shall be protected by a method that prevents birds and rodents from entering or blocking the vent pipe opening.

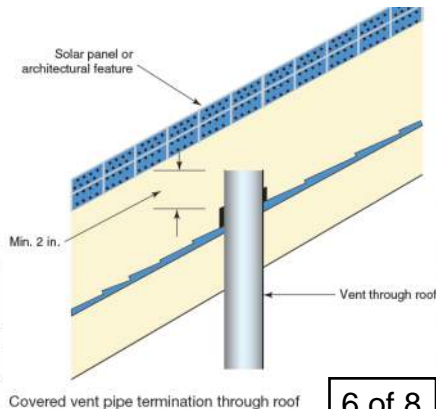

P3111.1 COMBINATION WASTE AND VENT SYSTEM CHANGE SUMMARY:

Food waste disposers are now permitted to connect to a combination waste and vent system sized for the total drainage fixture unit load in accordance with Table P3111.3.

**TABLE P3111.3
SIZE OF COMBINATION WASTE AND VENT PIPE**

DIAMETER PIPE (inches)	MAXIMUM NUMBER OF FIXTURE UNITS (d.f.u.)	
	Connecting to a horizontal branch or stack	Connecting to a building drain or building subdrain
2	3	4
2½	6	26
3	12	31
4	20	50

2021 ELECTRICAL CHANGES AS OF JANUARY 01, 2023

Smoke Alarm and CO Detector requirements REVISED, SEE Page 5 of this document.

E3601.8 Emergency Service Disconnects For one- and two-family dwelling units, all service conductors shall terminate in disconnecting means having a short-circuit current rating equal to or greater than the available fault current, **installed in a readily accessible outdoor location**. If more than one disconnect is provided, they shall be grouped. Service disconnects marked as follows: EMERGENCY DISCONNECT

E3606.5 Service Surge-Protective Device All services supplying one- and two-family dwelling units shall be provided with a surge-protective device (SPD) installed in accordance with Sections E3606.5.1 through E3606.5.3. **E3606.5.1 Location.** The SPD shall be an integral part of the service equipment or shall be located immediately adjacent thereto. Exception: The SPD shall not be required to be located in the service equipment if located at each next level distribution equipment downstream toward the load.

E3606.5.2 Type of Service Surge-Protective Device The SPD shall be a Type 1 or Type 2 SPD.

E3606.5.3 Replacement. Where service equipment is replaced, all of the requirements of this section shall apply. [230.67]

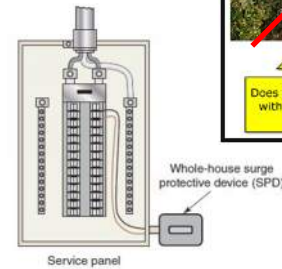

E3703.4 Bathroom branch circuits Only the required bathroom receptacle outlets or those serving a countertop need to be on the dedicated 20-amp bathroom circuit. Additional receptacle outlets may be 15amp. (GFCI Protected)

E4002.11 Bathtub and shower space Receptacles shall not be installed within a zone measured **3 feet (90 mm) horizontally** and **8 feet (2438 mm) vertically** from the top of the bathtub rim or shower stall threshold. The identified zone is all-encompassing and shall include the space directly over the tub or shower stall.

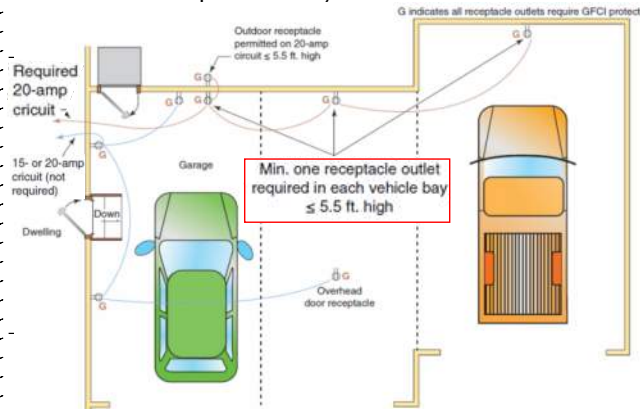

E3703.5 Garage branch circuits. Not less than one 120-volt, 20-ampere branch circuit shall be installed to supply receptacle outlets required by Section E3901.9 in attached garages and in detached garages with electric power. (GFCI Protected) This circuit shall not have other outlets. Exception: This circuit shall be permitted to supply readily accessible outdoor receptacle outlets.

E3901.9 Basements, garages and accessory buildings. Not less than one receptacle outlet, in addition to any provided for specific equipment, shall be installed in each separate unfinished portion of a basement; in each vehicle bay not more than 5.5 feet (1676 mm) above the floor in attached garages.

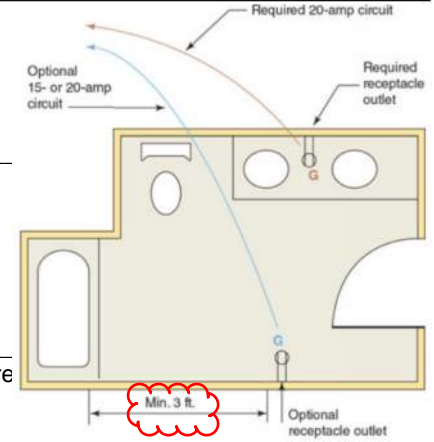

E3901.2.2 Wall space. As used in this section, a wall space shall include the following: [210.52(A)(2)] 1. Any space that is 2 feet (610 mm) or more in width, including space measured around corners, and that is unbroken along the floor line by door-ways and similar openings, fireplaces, and **fixed cabinets that do not have countertops or similar work surfaces.**

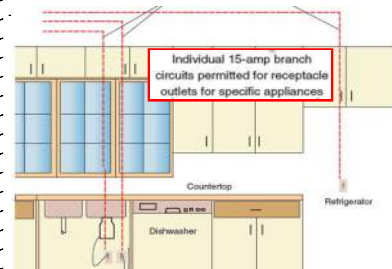

E3901.3 Small appliance receptacles. In the kitchen, pantry, breakfast room, dining room, or similar area of a dwelling unit, the two or more 20-ampere small-appliance branch circuits required by Section E3703.2, shall serve all wall and floor receptacle outlets covered by Sections E3901.2 and E3901.4 and those receptacle outlets provided for refrigeration appliances. **NEW Exception:** In addition to the required receptacles specified by Section E3901.2, **a receptacle outlet to serve a specific appliance shall be permitted to be supplied from an individual branch circuit rated at 15 amperes or greater.**

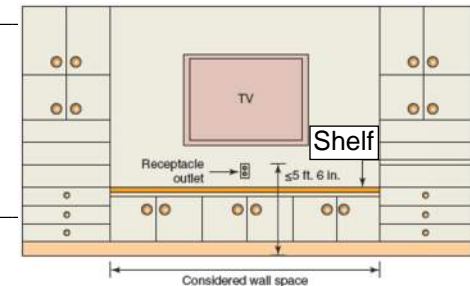

E3901.4.2 Island and peninsular countertops and work spaces. Receptacle outlets shall be installed in accordance with the following: 1. At least one receptacle outlet shall be provided for the **first 9 square feet** (0.84 m²), or fraction thereof, of the countertop or work surface. A receptacle outlet shall be provided for **every additional 18 square feet** (1.7 m²), or fraction thereof, of the countertop or work surface.

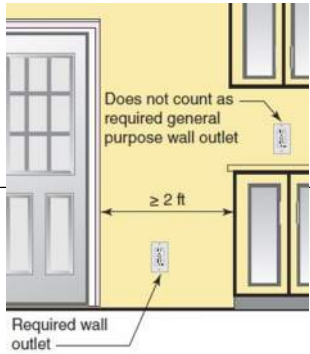

E3901.4 Countertop and work surface receptacles. Clarifies that countertop receptacles in kitchen areas cannot be counted as a required general-purpose wall space receptacle outlet for wall spaces > 2ft.

Island work surface:

- One receptacle outlet for first 9 sq. ft.
- One receptacle outlet for each additional 18 sq. ft. or fraction thereof

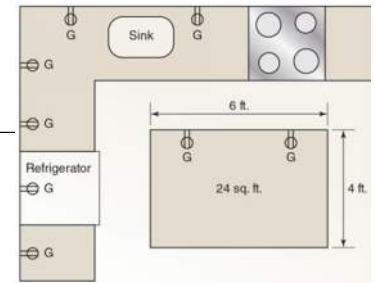

E3902 GROUND-FAULT AND ARC-FAULT CIRCUIT-INTERRUPTER PROTECTION

Ground-fault circuit-interrupter (GFCI) protection is required for up to **250-volt receptacles** in the areas previously identified as requiring GFCI protection for 125-volt receptacles. The 20-amp limitation has been removed. This includes damp/wet areas: Bathrooms, Garage and accessory building, Outdoors, Crawl space receptacles and lighting outlets, Kitchens, within 6ft of a sink or bath/shower, Laundry areas, Basements, and Boathouse receptacles (including Boat Hoists),

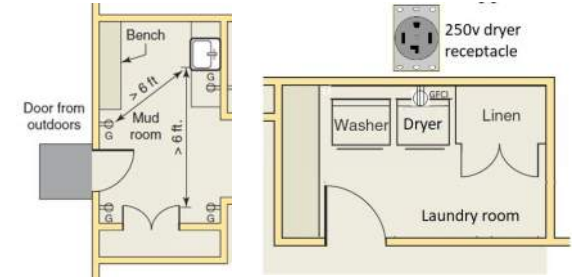

2021 MECHANICAL CHANGES AS OF JANUARY 01, 2023

M1502.3.1 Dryer exhaust duct terminations (Outlet) shall be undiminished in size and shall provide an open area of not less than **12.5 square inches**.

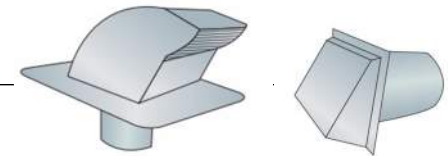

M1502.4.2 Duct installation. Where dryer exhaust ducts are enclosed in wall or ceiling cavities, such cavities shall allow the installation of the duct without deformation. Exhaust ducts shall be supported at intervals not to exceed 12 feet (3658 mm) and shall be secured in place. The insert end of the duct shall extend into the adjoining duct or fitting in the direction of airflow. Exhaust duct joints shall be sealed in accordance with Section M1601.4.1 and shall be mechanically fastened. Ducts shall not be joined with screws or similar fasteners that protrude more than 1/8 inch (3.2 mm) into the inside of the duct.

M1503.6 Exhaust Systems – (i.e. Kitchen Exhaust hoods or other exhaust) **Where one or more gas, liquid or solid fuel-burning appliance that is neither direct-vent nor uses a mechanical draft venting system is located within a dwelling unit's air barrier,** each exhaust system capable of exhausting in excess of 400 cubic feet per minute shall be mechanically or passively provided with makeup air at a rate approximately equal to the exhaust air rate. Such makeup air systems shall be equipped with not fewer than one damper complying with Section M1503.6.2.

